

Name : _____ () Date: _____

Class : Primary 5 (SY/C/G/SE/P)

Time : 2 h 15 min

SINGAPORE CHINESE GIRLS' SCHOOL
SECOND SEMESTRAL ASSESSMENT 2007

PRIMARY 5
MATHEMATICS
BOOKLET A

15 Questions

25 Marks

Total Time For Booklets A and B : 2 h 15 mins

DO NOT OPEN THIS BOOKLET UNTIL YOU ARE TOLD TO DO SO.

FOLLOW ALL INSTRUCTIONS CAREFULLY.

ANSWER ALL QUESTIONS.

Name : _____ ()

Date : _____

Class : Primary 5 SY/C/G/SE/P

Time : 2 h 15 min

Booklet A (20 marks)

Questions 1 to 10 carry 1 mark each. Questions 11 to 15 carry 2 marks each. For each question, four options are given. One of them is the correct answer. Make your choice (1, 2, 3 or 4). Shade the correct oval (1, 2, 3 or 4) on the Optical Answer Sheet.

1. Write in figures - 600 thousands, 40 hundreds and 15 tens.

- (1) 600 415
- (2) 604 150
- (3) 640 150
- (4) 641 500

2. Arrange the following in ascending order $\frac{11}{12}$, $\frac{1}{2}$, $\frac{1}{3}$, $\frac{3}{4}$, $\frac{5}{6}$:

- (1) $\frac{11}{12}$, $\frac{5}{6}$, $\frac{3}{4}$, $\frac{1}{2}$, $\frac{1}{3}$
- (2) $\frac{11}{12}$, $\frac{3}{4}$, $\frac{5}{6}$, $\frac{1}{3}$, $\frac{1}{2}$
- (3) $\frac{1}{3}$, $\frac{1}{2}$, $\frac{3}{4}$, $\frac{5}{6}$, $\frac{11}{12}$
- (4) $\frac{1}{3}$, $\frac{1}{2}$, $\frac{3}{4}$, $\frac{11}{12}$, $\frac{5}{6}$

3. Divide 89.16 by 3.

- (1) 297.2
- (2) 29.92
- (3) 29.72
- (4) 27.72

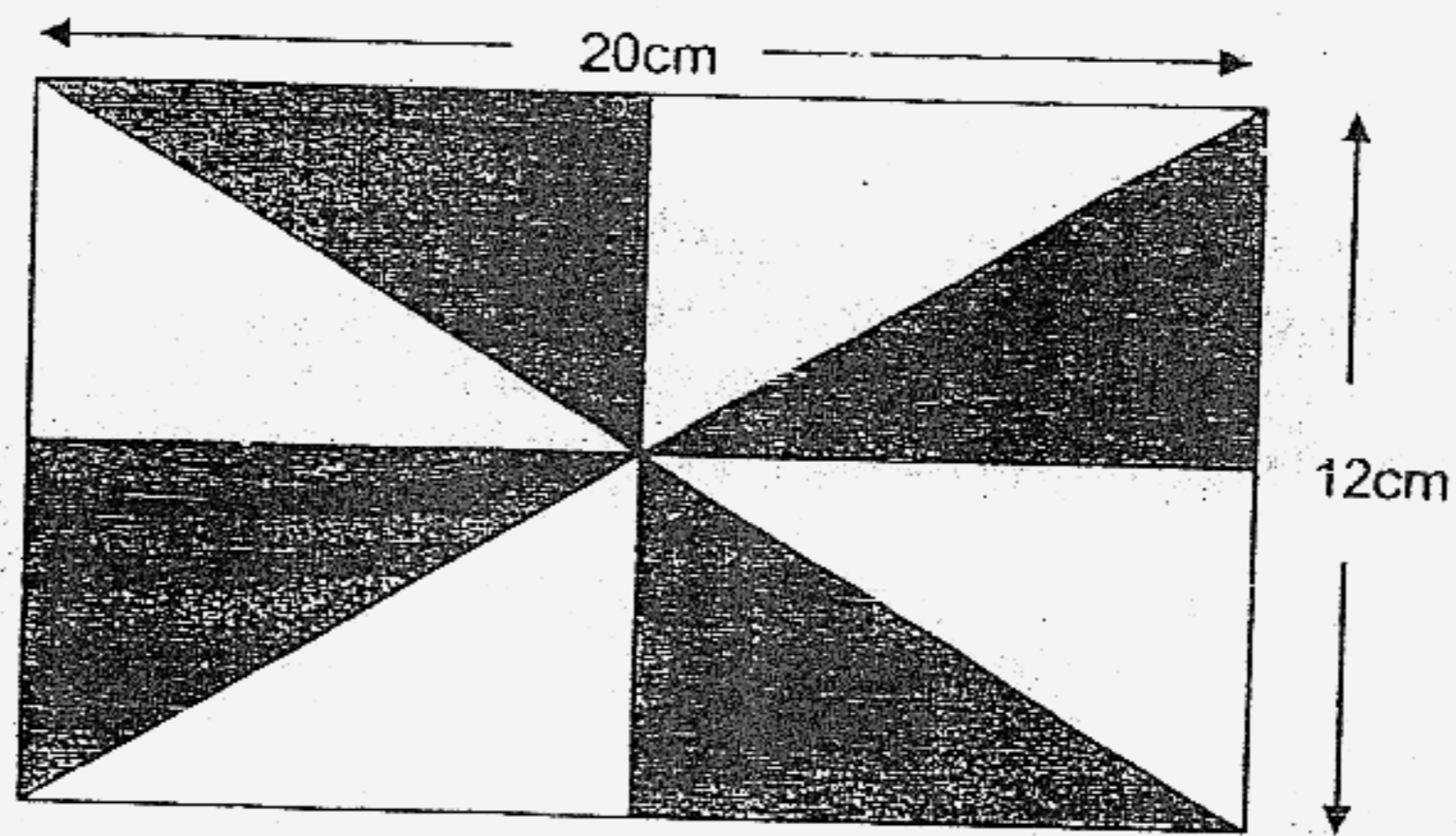

4. The above figure is made up of 8 identical triangles. What is the shaded area of the figure?

- (1) 30 cm^2
- (2) 60 cm^2
- (3) 120 cm^2
- (4) 240 cm^2

5. What is the total volume of the three 6-cm cubes?

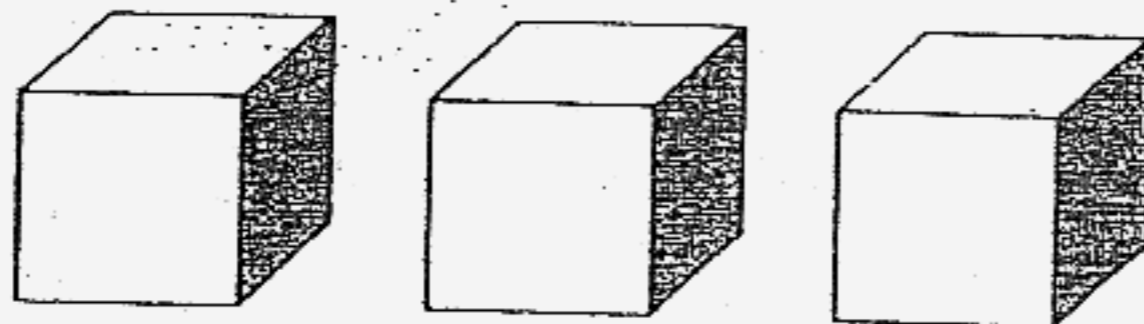

- (1) 36 cm^3
- (2) 108 cm^3
- (3) 216 cm^3
- (4) 648 cm^3

6. A carpenter saw a plank 6.48 m long into 3 equal pieces. What was the length of each piece of plank?

- (1) 2.16 cm
- (2) 2.03 m
- (3) 213 cm
- (4) 2.16 m

7. Through how many right angles does the minute hand turn in one hour?
- (1) 1
 - (2) 2
 - (3) 6
 - (4) 4
8. The average mass of five boys is 52 kg. The first 4 boys have a mass of 43 kg, 60 kg, 55 kg and 49 kg respectively. What is the mass of the fifth boy?
- (1) 52 kg
 - (2) 53 kg
 - (3) 57 kg
 - (4) 63 kg
9. The ratio of the amount of orange syrup to the amount of water used in making an orange drink is 3 : 7. If 900ml of orange syrup was used, how much water was used?
- (1) 300 ml
 - (2) 450 ml
 - (3) 630 ml
 - (4) 2100 ml
10. Express $\frac{1}{20}$ as a percentage.
- (1) 5%
 - (2) 10%
 - (3) 15%
 - (4) 20%
11. Jessie is 12 years younger than her cousin. In 2 years' time, her cousin will be 30 years old. How old is Jessie now?
- ~~(1) 16 years old~~
 - ~~(2) 18 years old~~
 - ~~(3) 20 years old~~
 - ~~(4) 26 years old~~

12. 9 mangoes cost ~~\$24.30~~ ^{\$19.35}. How much do ~~7~~ ⁸ mangoes cost?

- ~~(1)~~ \$2.70
- ~~(2)~~ \$17.20
- ~~(3)~~ \$17.90
- ~~(4)~~ \$218.70

13. The line graph shows the total number of books sold in the first 6 days of its launch.

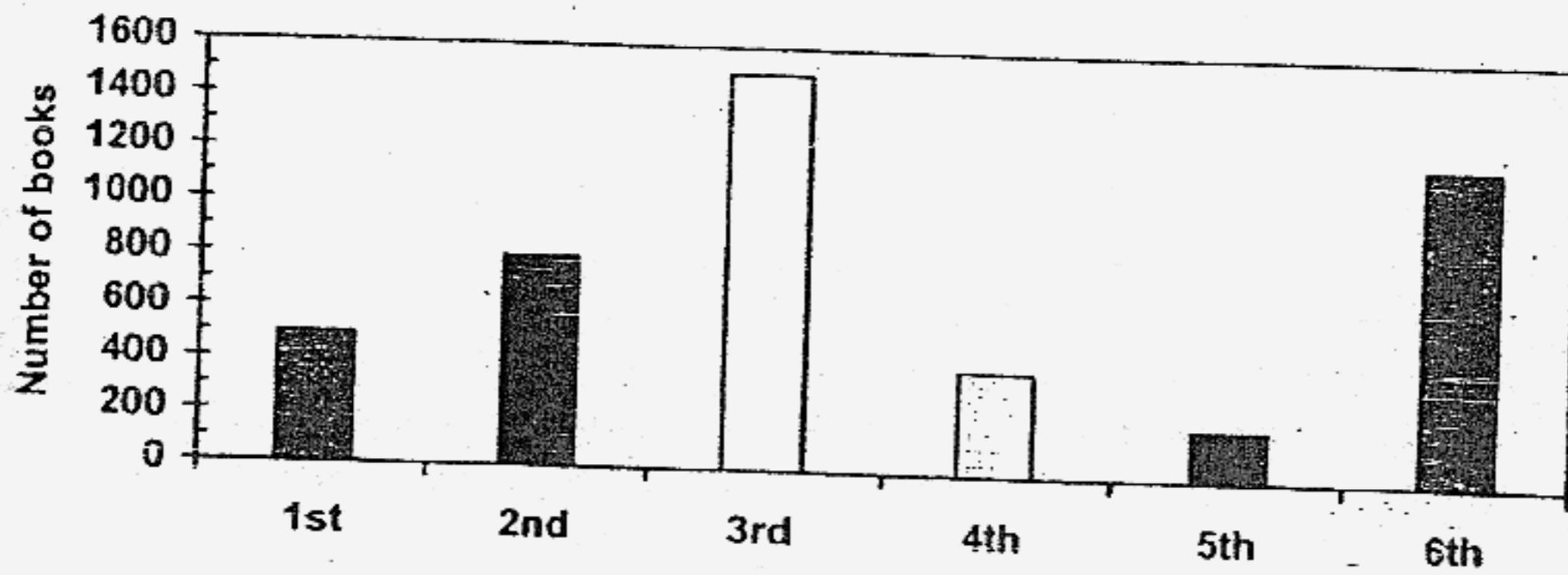

In which day did the number of books sold decrease the most, when compared to the previous day?

- (1) 1st day
- (2) 4th day
- (3) 5th day
- (4) 6th day

14. The diagram below is not drawn to scale. ABD is an isosceles triangle and ABC is a straight line. Find $\angle DBC$.

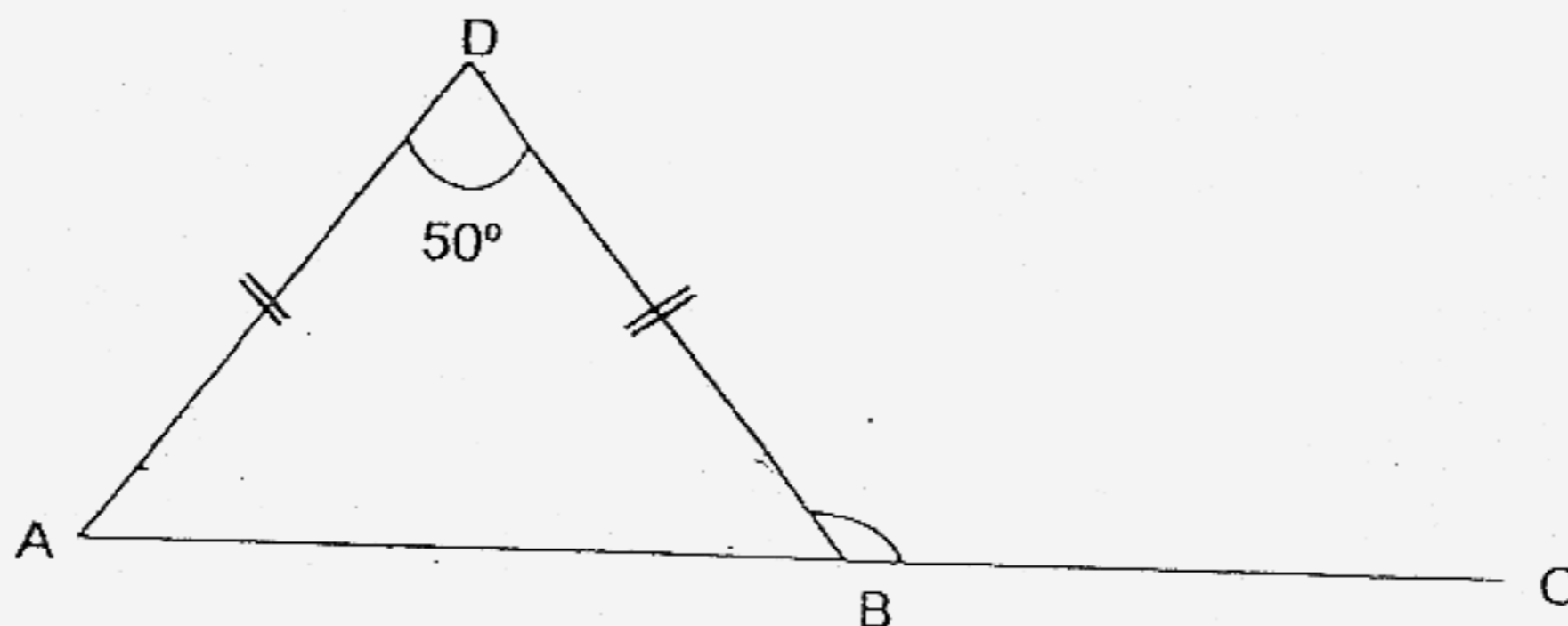

- (1) 65°
- (2) 115°
- (3) 130°
- (4) 140°

15. Mr Chong and his family ordered dishes at a restaurant which amounted to \$210 in all. The restaurant charges 10% service charge and 7% GST. How much did Mr Chong pay for the meal?

- ~~(1)~~ \$224.70
- ~~(2)~~ \$231.00
- ~~(3)~~ \$245.70
- ~~(4)~~ \$247.80

48

Name : _____ ()

Date : _____

Class : Primary 5 (S/C/G/SE/P)

Time : 2 h 15 min

Booklet B (80 marks)

Questions 16 to 25 carry 1 mark each. Questions 26 to 35 carry 2 marks each.
For each question, write your answer in the space provided.
Give your answers in the units stated.

Do not write
in this column

16. Find the value of $60 - 15 \div 5 \times 2$.

Ans: _____

17. Express $1\frac{2}{3}$ in decimals. (Rounded off your answer to two decimal places)

Ans: _____

18. What fraction of \$45 is \$3?

Ans: _____

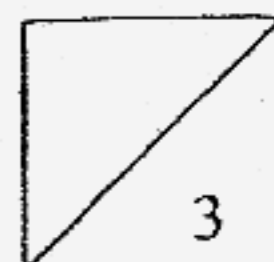

19. Given that the volume of the solid is 2496 cm^3 , find the height of the solid.

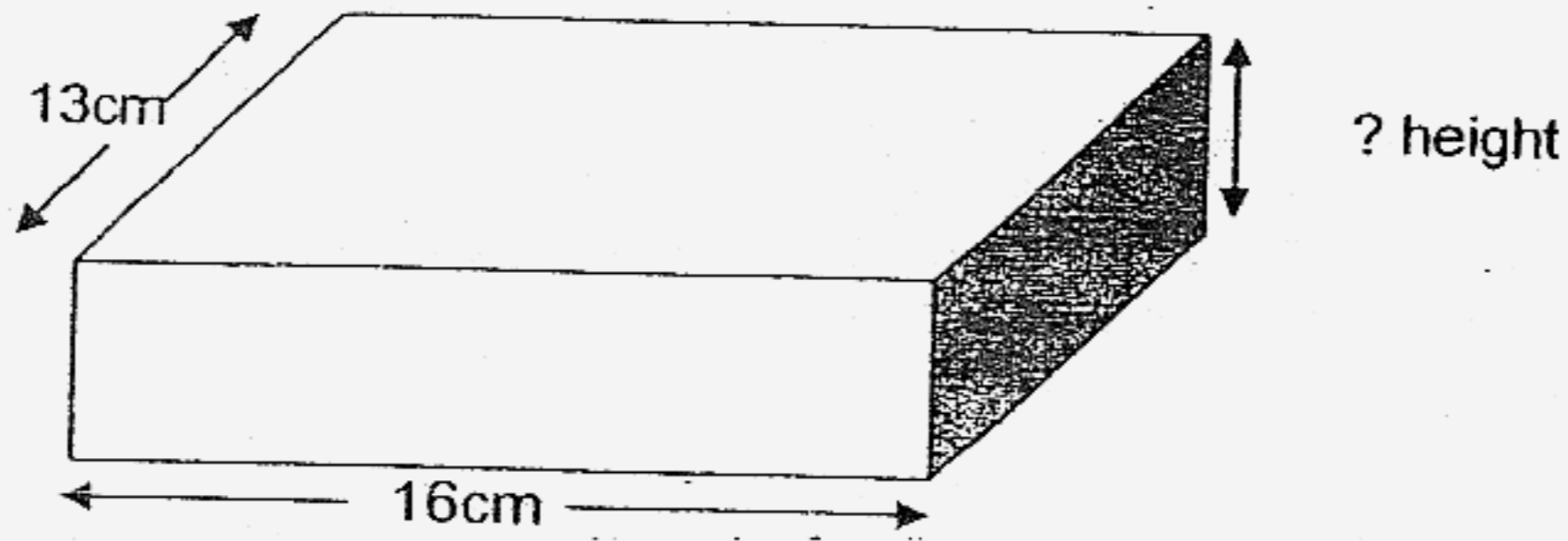

Do not write
in this column

Ans: _____ cm

20. Mrs Foo sold rambutans on Monday and Tuesday. If the amount of rambutans sold on Tuesday is twice the amount sold on Monday, how much will she have sold altogether if she sold 1500g of rambutans on Tuesday?

Ans: _____ kg _____ g

21. What is the area of the ^{shaded} triangle?

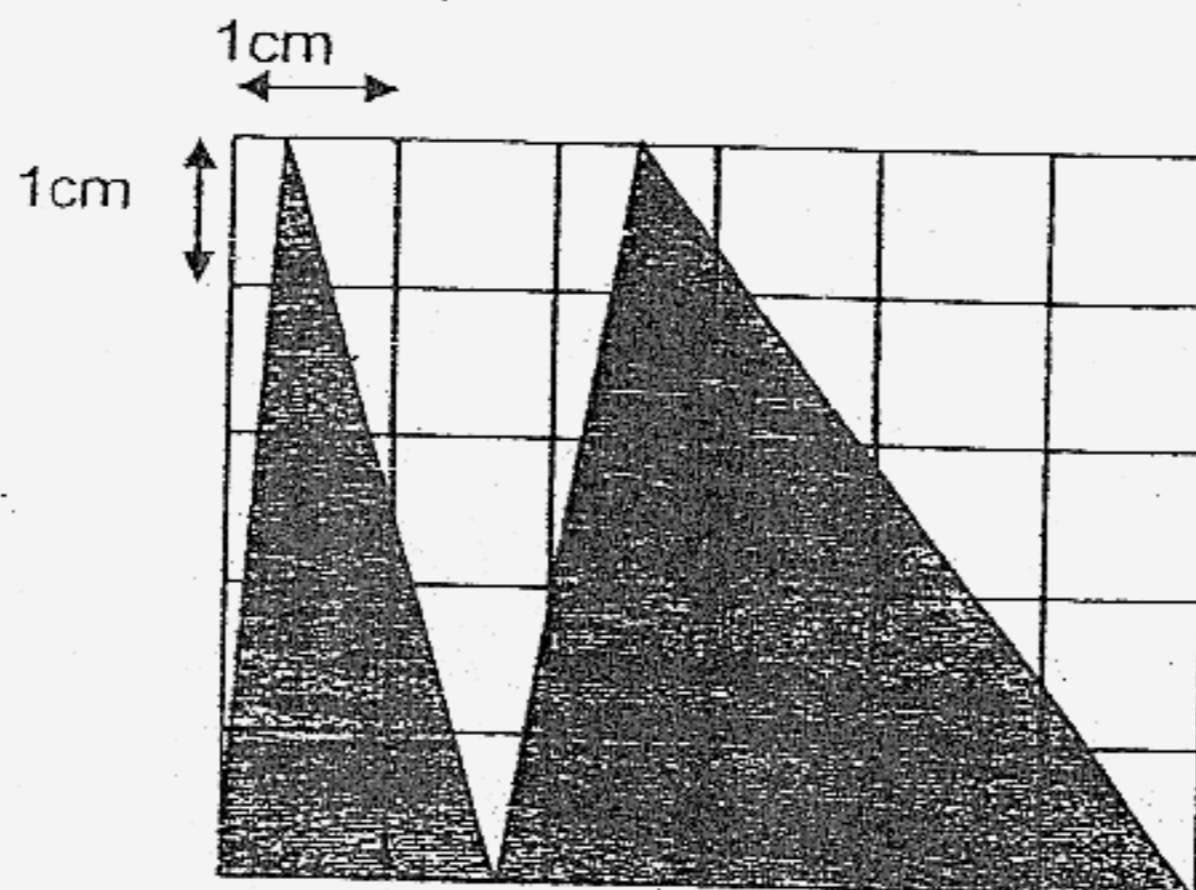

Ans: _____ cm^2

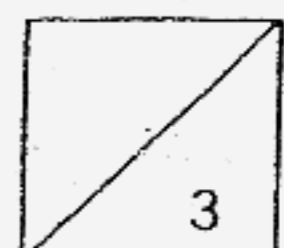

22. Draw a line perpendicular to line AB that passes through point X.

Do not write
in this column

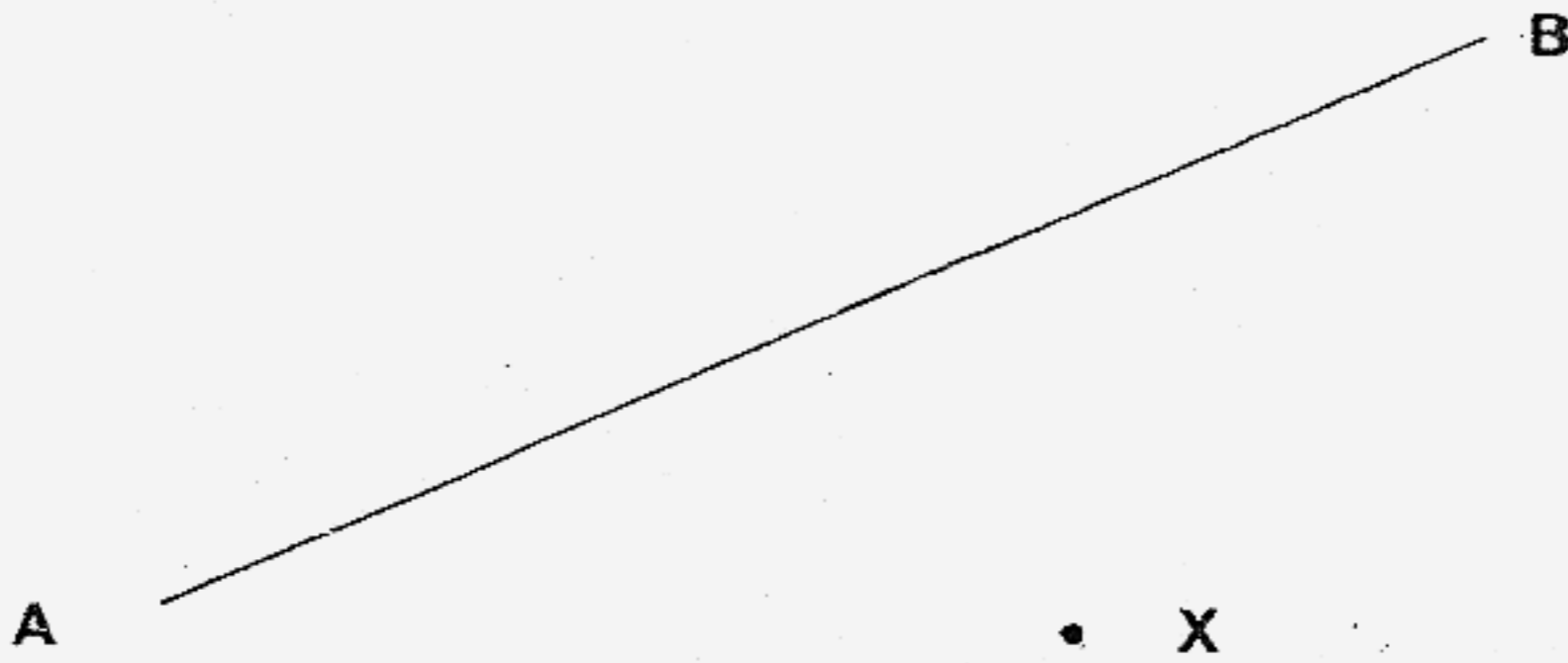

23. Find the value of $\angle a$.

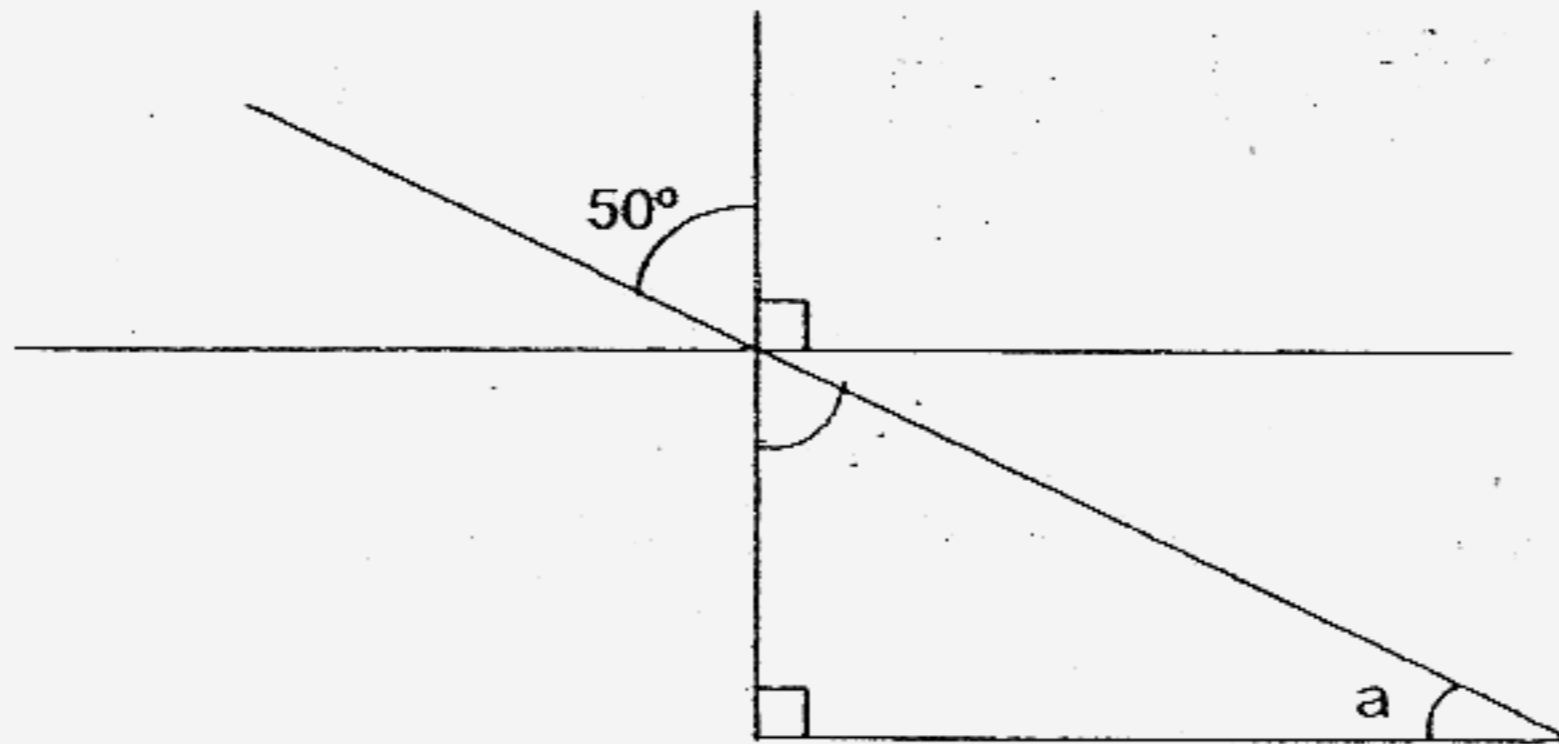

Ans: _____^o

24. A fruit seller peeled 6 oranges in 3 minutes. What is the average number of oranges she peeled in a minute?

Ans: _____

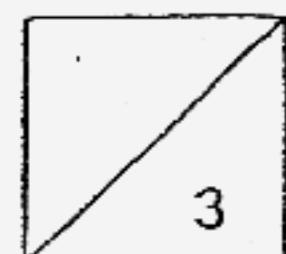

25. Aini gave 35% of her marbles to Bala. What fraction of her marbles had she left?

Do not write
in this column

Ans: _____

Questions 26 to 35 carry 2 marks each. Show your working clearly in the space below each question and write your answers in the spaces provided. For questions which require units, give your answers in the units stated.

26. Mrs Wong spent half of her money on a handbag and the rest on 4 similar purses. If each purse cost \$22, how much did she have at first?

Ans: \$ _____

27. Mr Wu spent 1 h 20 min to wash his car and then another 55 min to polish it. If he finished cleaning his car at 11.35am, at what time did he start cleaning his car?

Ans: _____

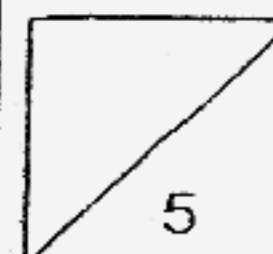

28. A water bottle costs \$16.20. A plastic bowl costs $\frac{1}{10}$ as much as a water bottle. What is the total cost of a water bottle and a plastic bowl?

Do not write
in this column

Ans: \$ _____

29. What is the length of the eraser?

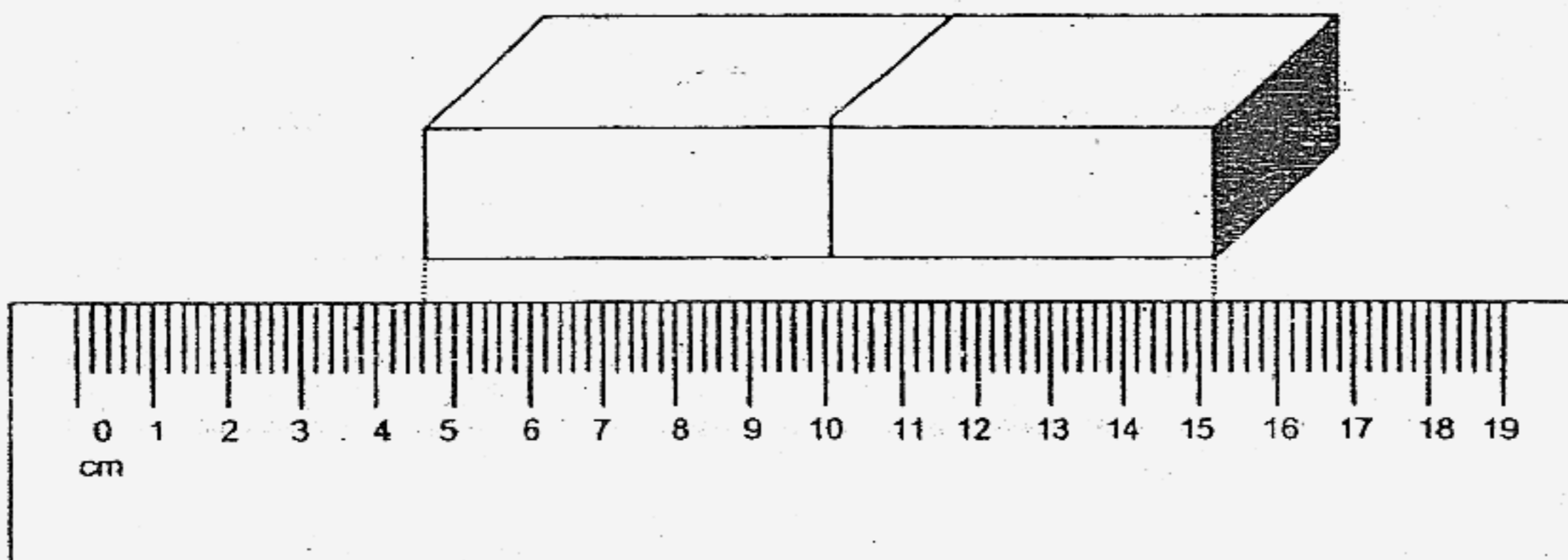

Ans: _____ cm

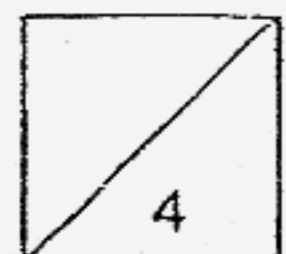

30. The line graph shows the sales of donuts at a donut factory in one week. Study the graph carefully.

Do not write
in this column

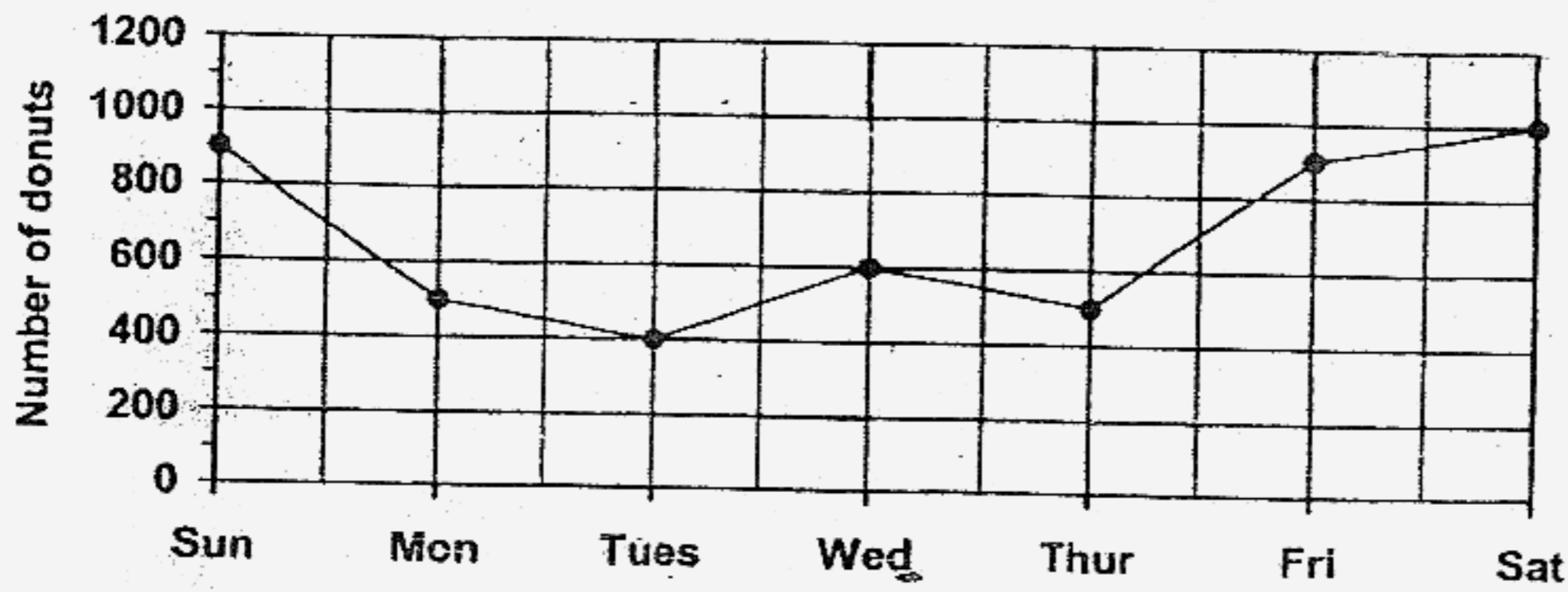

- (a) What is the difference between the most number of donuts sold in a day, and the least number of donuts sold in a day?
- (b) What was the average number of donuts sold ^{from Mon to Sat?} ~~for that week?~~

Ans: (a) _____

(b) _____

31. In the figure not drawn to scale, AD and BC are straight lines. Find $\angle ABO$.

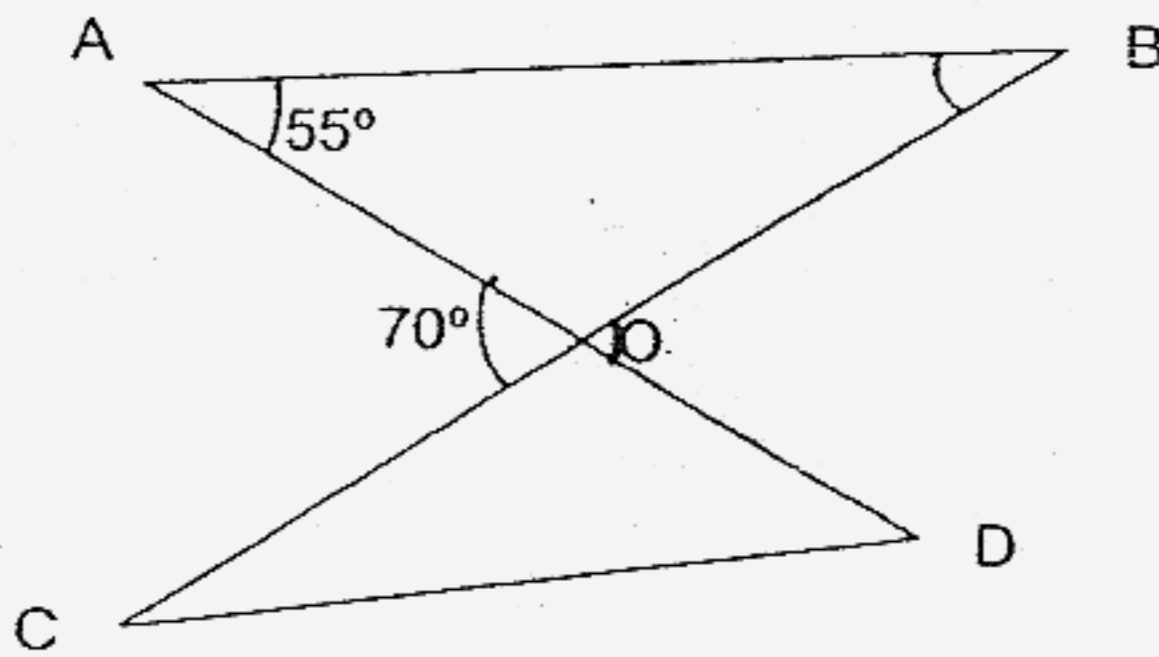

Ans: _____°

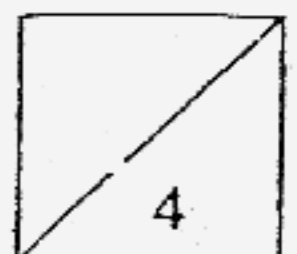

32. A pail with a capacity of 5.25 l is put under a dripping tap. After 20 minutes, the pail becomes half filled. At what rate is water dripping from the tap? (Give your answers in l / hr)

Ans: _____ l / hr

33. Mr Raju can make an average of 20 roti pratas in 15 minutes. His assistant can make 1 prata per minute. At these rates, how long does it take them to make 140 pratas if they start making the pratas at the same time?

Ans: _____

34. Harry, Billy and Neville bought some computer games and shared out the cost in the ratio 5 : 4 : 1 respectively. If Harry paid \$36 more than Neville, how much did the computer games cost?

Ans: _____

35. Deborah bought a refrigerator at a discount of 30%. She paid \$621.60 for it. What is the original price of the refrigerator?

Ans: _____

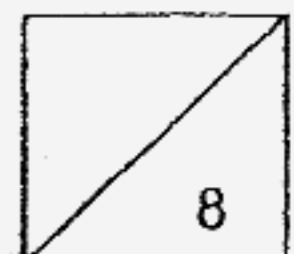

Name : _____ () Date : _____

Class : Primary 5 (SY/C/G/SE/P)

Time : 2 h 15 min

Do not write
in this column

Write your answers to questions 36 to 48 in the spaces provided. For each question, show your working clearly in the space provided. The number of marks available is shown in brackets at the end of each question or part-question.

36. Linette bought 2 dolls and 5 books for \$154. Each doll cost 3 times as much as a book.

(a) Find the price of a doll.

(b) Find the difference in price between a doll and a book.

Ans: (a) _____(2)

(b) _____(1)

37. Three girls, Anna, Beatrice and Calista shared a roll of ribbons.

Anna's share was $\frac{1}{4}$ of the total length of Beatrice's and Calista's ribbons.

Beatrice's share was $\frac{2}{3}$ of the total length of Anna's and Calista's ribbons.

If Anna's share of ribbons is 45cm less than Beatrice's share, what is the total length of the roll of ribbons?

Ans: _____(3)

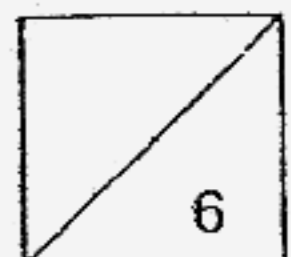

38. Figure ABCD is a rhombus. AC and BD are straight lines. AC = 10cm, BD = 14cm.

(a) Find $\angle OAD$. (1m)

(b) Find the area of triangle DOC. (2m)

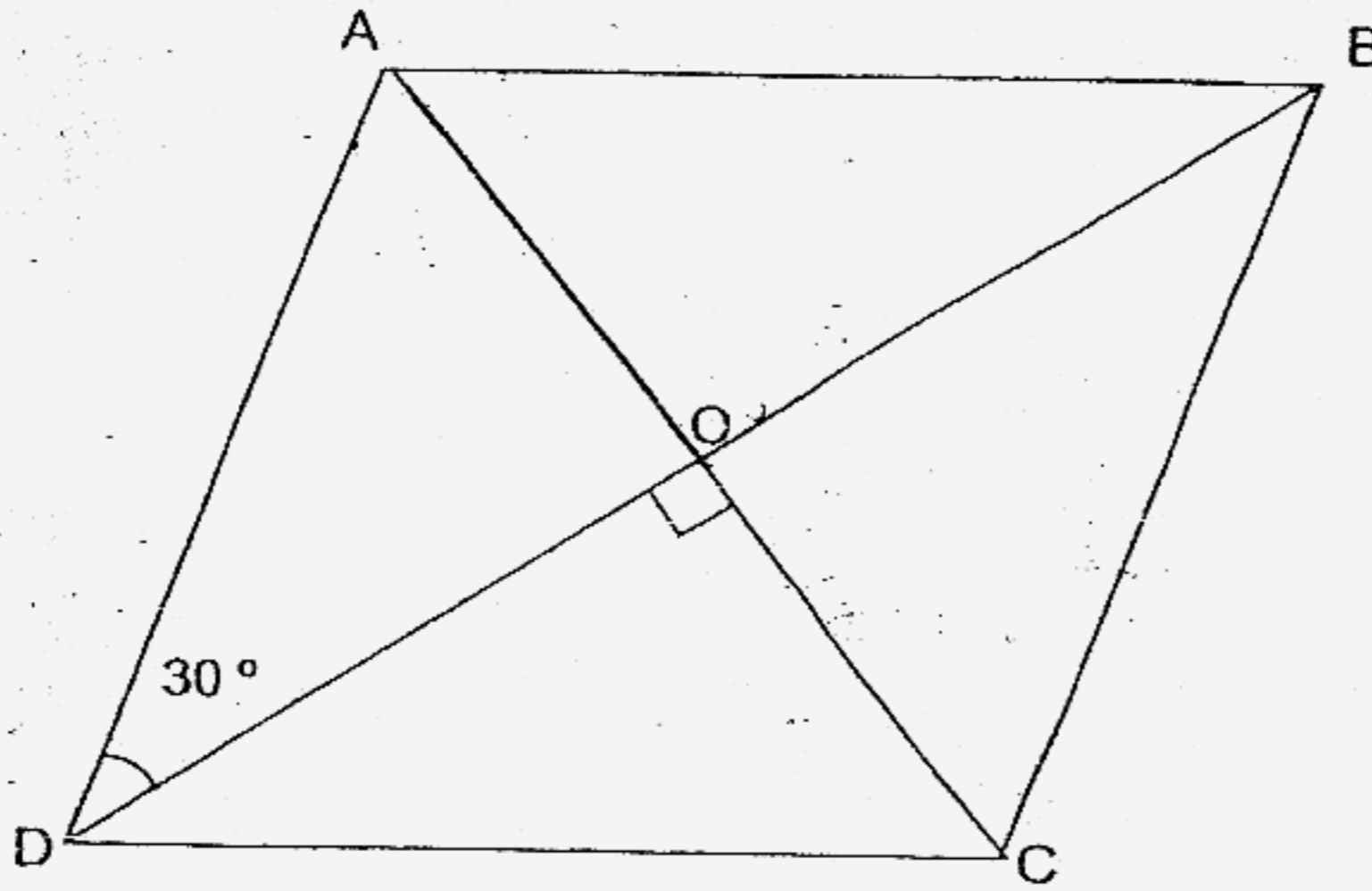

Do not write
in this column

Ans: (a) _____ 6

(b) _____ cm^2

39. The mass of a basket of lychees was 27 kg. Some pineapples that were placed in a similar basket had a mass of 21 kg. The mass of the pineapples was $\frac{3}{4}$ the mass of the lychees. Find the mass of the empty basket.

Ans: _____ kg (3)

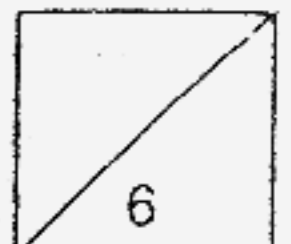

40. (a) Shade a unit shape of the tessellation. (1)
 (b) Extend 4 more unit shapes (2)

Do not write
 in this column

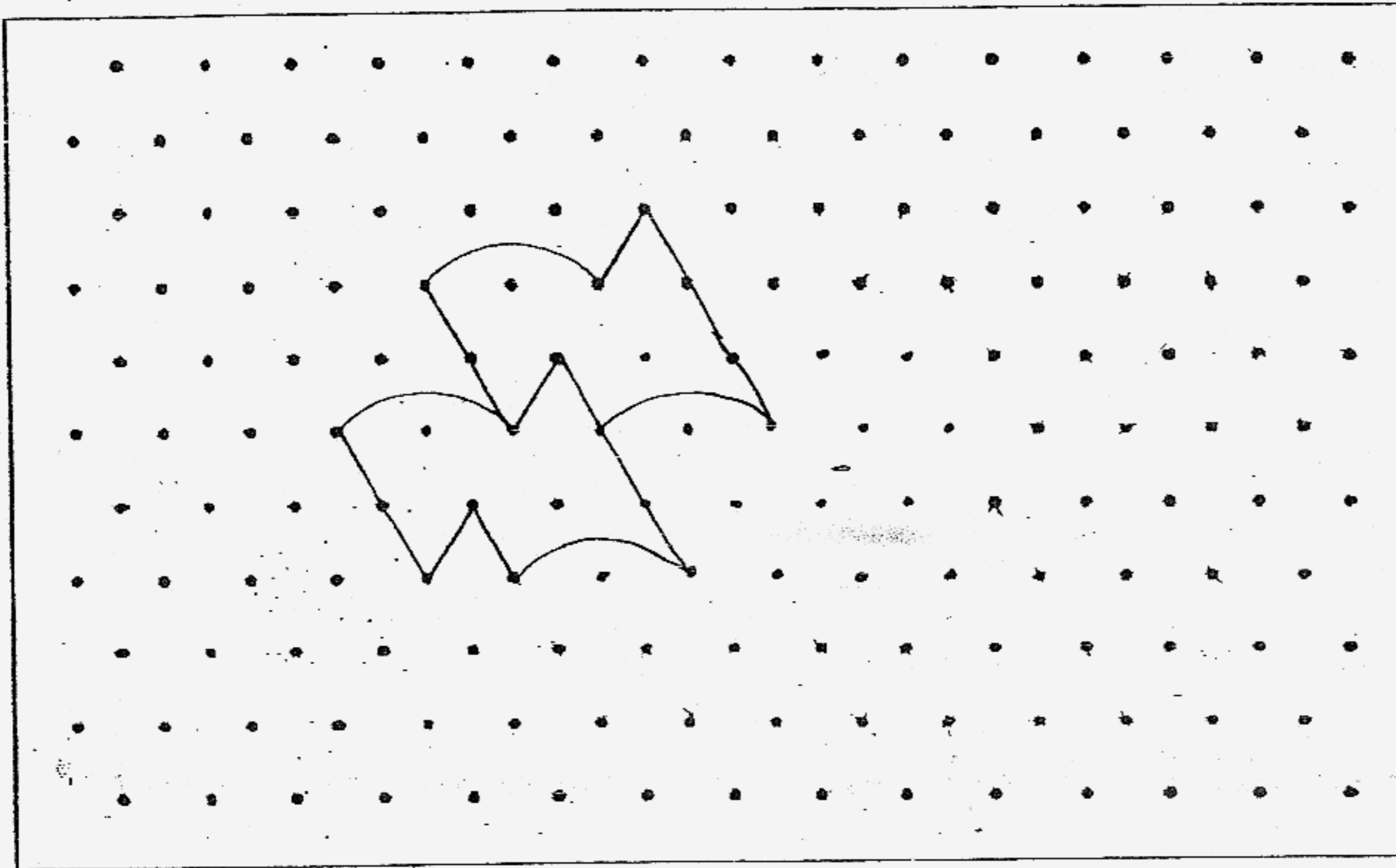

41. Shelley saved 10% of her monthly salary and spent 20% of the remainder on room rental every month. If she spent \$4320 on room rental a year, how much does she earn in a month?

Ans: _____ (3)

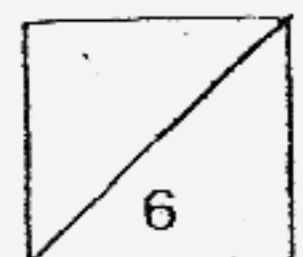

42. It takes 3 jugs and 8 mugs of water to fill up a fish tank. ^{IF} The capacity of a mug is $\frac{1}{5}$ the capacity of a jug, what is the capacity of the fish tank given that a jug can hold 0.75l of water?

Do not write
In this column

Ans: _____ (4)

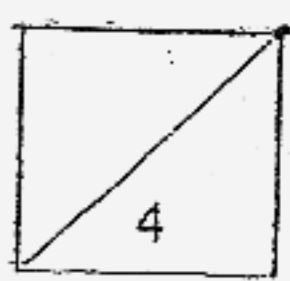

43. The graph shows the number of pupils who visited a canteen stall in a week.

Do not write
in this column

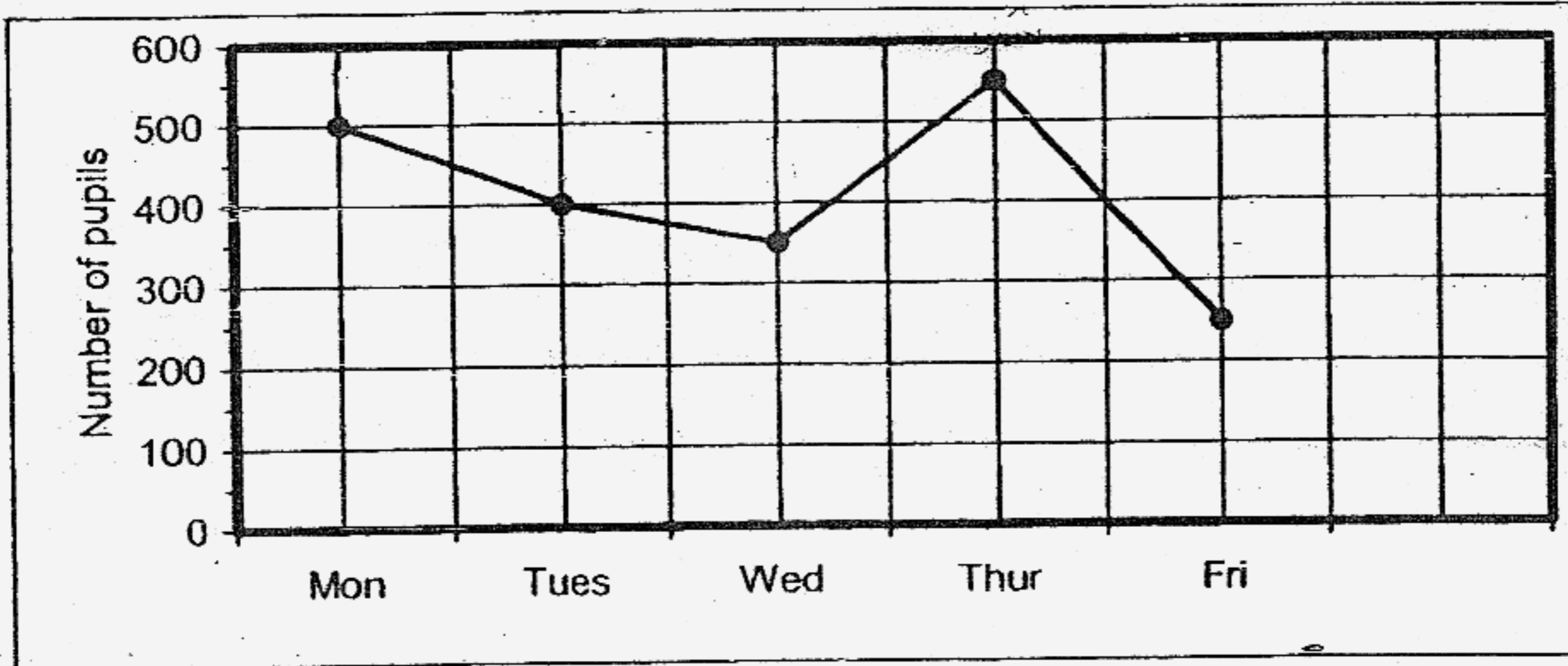

- (a) What was the difference between the greatest number and the smallest number of pupils who visited the stall?
- (b) On which day was the number of pupils who visited the stall $\frac{4}{5}$ of the number of pupils who visited the stall on Monday?
- (c) What is the average number of pupils who visited the stall per day?

Ans: (a) _____ (1m)

(b) _____ (1m)

(c) _____ (2m)

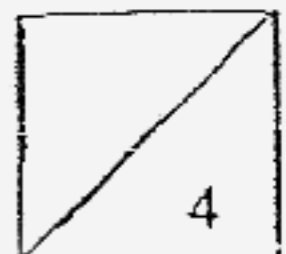

44(a) Construct a triangle ABC such that $AB = 7 \text{ cm}$, $BC = 5 \text{ cm}$ and $\angle ABC = 60^\circ$. . (2)

Do not write
In this column

44(b) Given that AB is the base of the triangle, draw and measure the height of the triangle ABC. (2)

Ans: (b) _____ cm

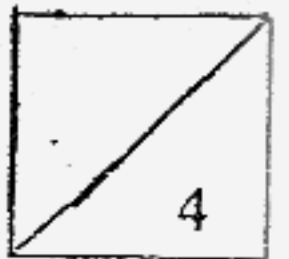

5. Rachel bought 4 times as many key chains as pencil cases. She spent \$180.90 in total and \$56.70 more on key chains than the pencil cases. The pencil cases cost \$1.20 more than the keychains. Find the cost of a ~~key~~ chain.

Key

Do not write
in this column

Ans: _____ (5)

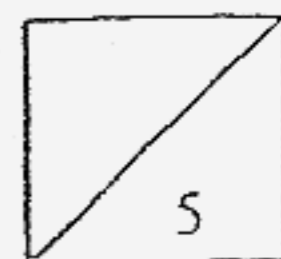

46. (a) The ratio of the shaded area to the unshaded area is 7 : 2.
Find the area of the unshaded area.

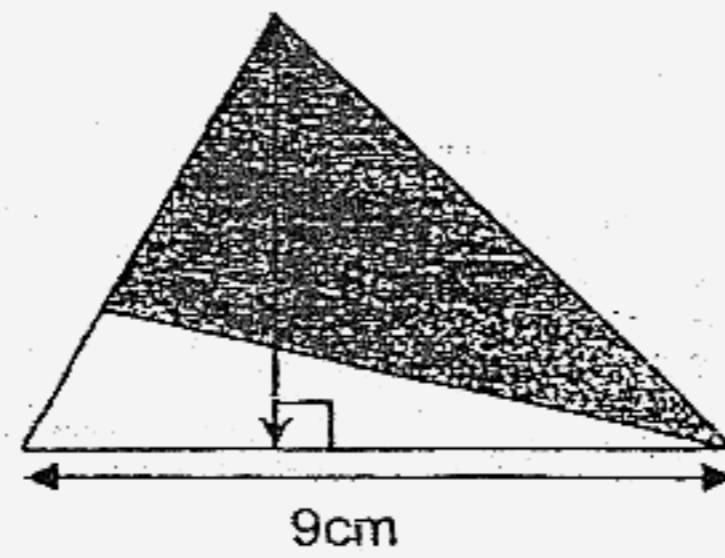

Ans: (a) _____ (2)

- (b) A strip of rectangular paper was folded as shown below.
Find the perimeter and area of the strip of paper.

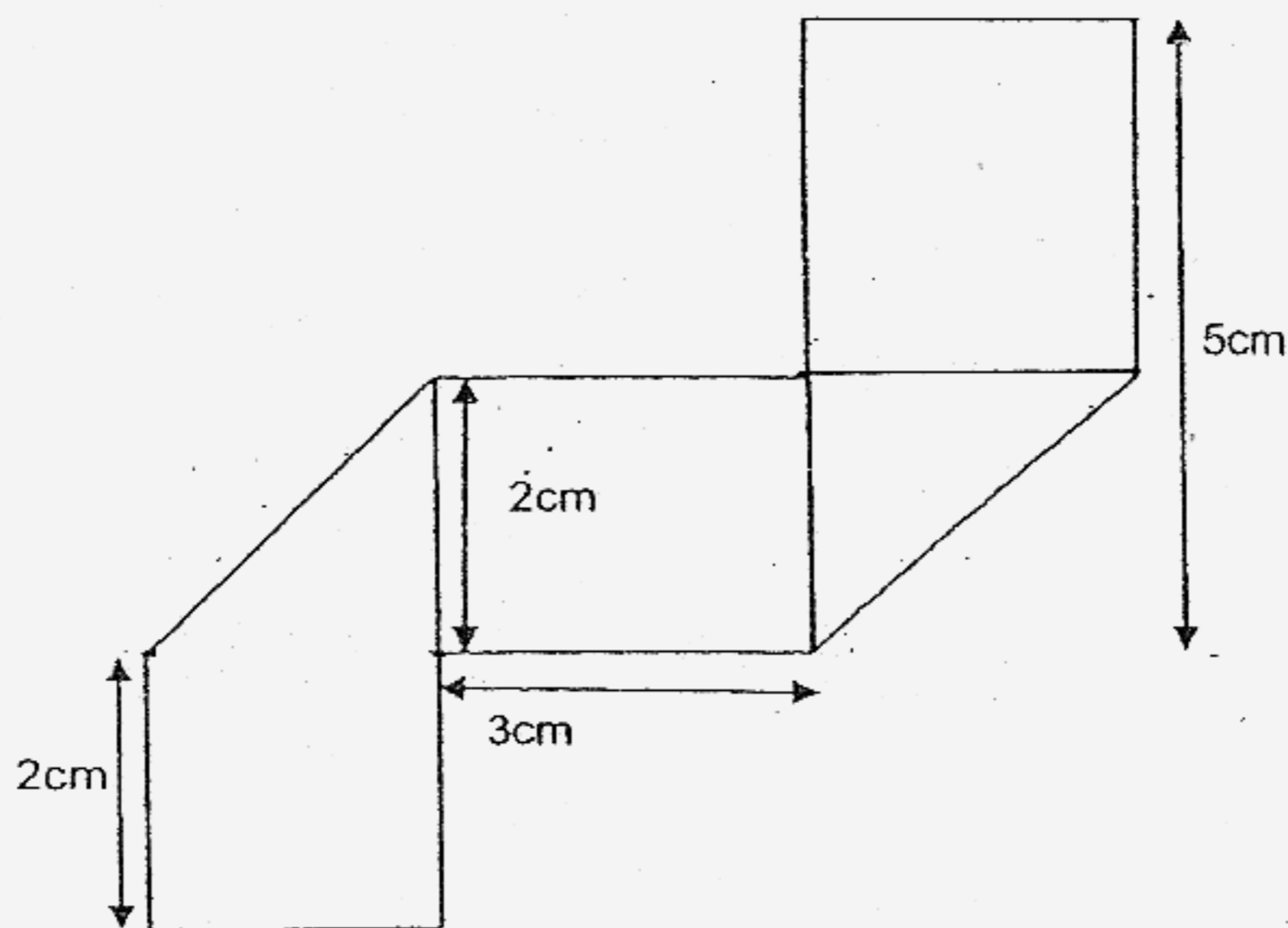

Ans: Perimeter: _____ (2)
Area: _____ (1)

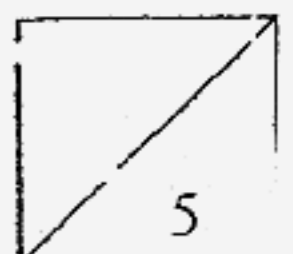

47. A rectangular tank with a base measuring 20 cm long and 16 cm wide ^{is being filled} with water. A tap fills the tank up at a rate of 20 ml per minute. If it takes $5\frac{1}{3}$ hour for the tank to be filled to the brim, what was the height of the tank?

Do not write
in this column

Ans: _____ (5)

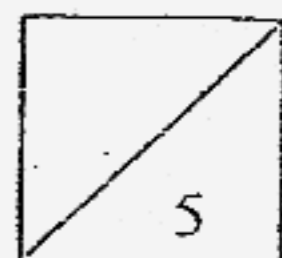

Do not write
in this column

48. There were some red, blue and white balls in a box. After 10 red balls and 5 blue balls were removed from the box, the ratio of red to blue balls was 4 : 9. When 16 more white balls were added in the box, the ratio of blue to white balls was 3 : 4. If there were 44 white balls at first, what was the ratio of red, to blue, to white balls at first?

Ans: _____ (5)

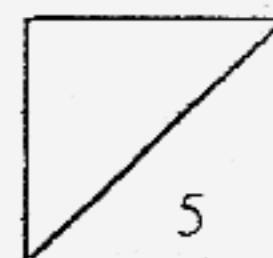

**END OF PAPER
PLEASE CHECK YOUR WORK**

SCGS Primary School

Primary 5 Maths SA2 Exam (2007)

Answer Keys

Q1	Q2	Q3	Q4	Q5
2	3	3	3	4
Q6	Q7	Q8	Q9	Q10
4	4	2	4	1
Q11	Q12	Q13	Q14	Q15
1	2	2	2	3

16. 54

17. 1.67

18. $\frac{2}{15}$

19. 12cm

20. 2kg 250g

21. 15cm²

22.

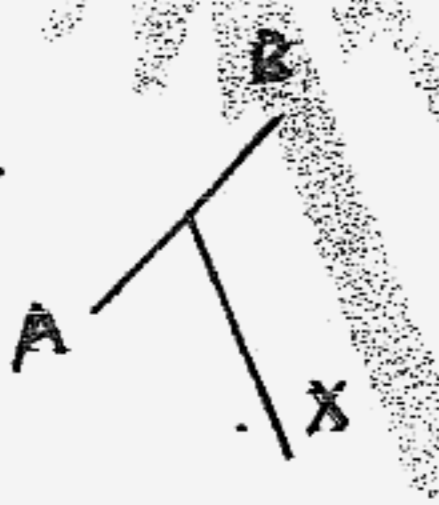

23. 40°

24. 2

25. $\frac{13}{20}$

26. \$176

27. 9.20am

28. \$17.82

29. 10.6cm

30a. Most = 1000
 Least = 400
 Different = 1000 - 400 = 600

30b. Total = 500 + 400 + 600 + 500 + 900 + 1000
 = 3900
 Average = 3900 ÷ 6 = 650

31. $\angle x = 70^\circ$
 $\angle y = (360^\circ - 70^\circ - 70^\circ) \div 2$
 $= 110^\circ$
 $\angle ABO = 180^\circ - 110^\circ - 55^\circ = 15^\circ$
32. 7.875
33. 1 hour
34. \$90
35. \$888
- 36a. $1u = \$154 \div 11 = \14
 $3u = \$14 \times 3 = \42 (Doll)
- 36b. $1u = \$14$ (Book)
 $3u = \$42$ (Doll)
Different = $\$42 - \$14 = \$28$
37. 225cm
- 38a. $\angle x = 180^\circ - 90^\circ - 30^\circ = 60^\circ$
 $\angle y = (360^\circ - 90^\circ - 90^\circ) \div 2$
 $= 90^\circ$
 $\angle OAD = 180^\circ - 90^\circ - 30^\circ = 60^\circ$
- 38b. $OC = 10\text{cm} \div 2 = 5\text{cm}$
 $OD = 14\text{cm} \div 2 = 7\text{cm}$
Area of DOC = $\frac{1}{2} \times 5 \times 7 = 17.5\text{cm}^2$
39. $1u = 27\text{kg} - 21\text{kg} = 6\text{kg}$
 $3u = 18\text{kg}$
Basket = $(21 - 18)\text{kg}$
 $= 3\text{kg}$

40.

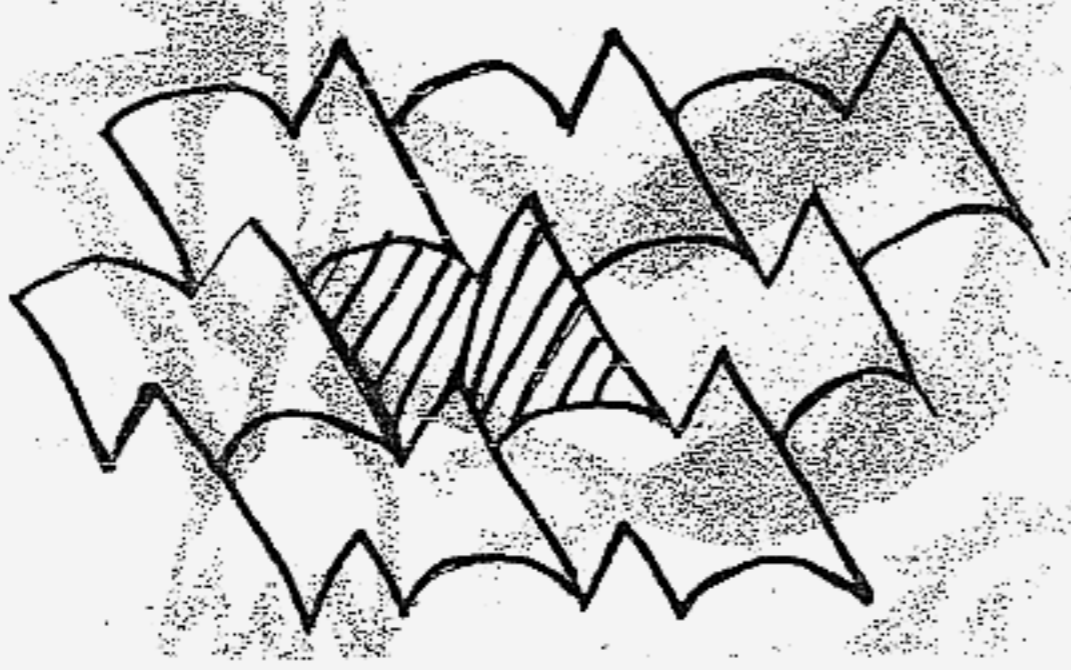

41. 12 months = \$4320
1 month = \$360
20% of remainder = \$360
100% of remainder = \$360 x 5
= \$1800
90% = \$1800
10% = \$200
100% = \$2000

42. $\frac{5}{5}$ mug = 0.75l
 $\frac{1}{5}$ mug = 0.75l \div 5 = 0.15l
3 jugs = 0.75l x 3 = 2.25l
8 mugs = 0.15l x 8 = 1.20l
Capacity of fish tank = 1.20l + 2.25l = 3.45l

43a. Greatest number = 550
Smallest number = 250
Different = 550 - 250
= 300

43b. $\frac{5}{5}$ = 500
 $\frac{1}{5}$ = 100
 $\frac{4}{5}$ = 400
400 = Tuesday

43c. Total = 500 + 400 + 350 + 550 + 250 = 2050
Average = 2050 \div 5
= 410

44a.

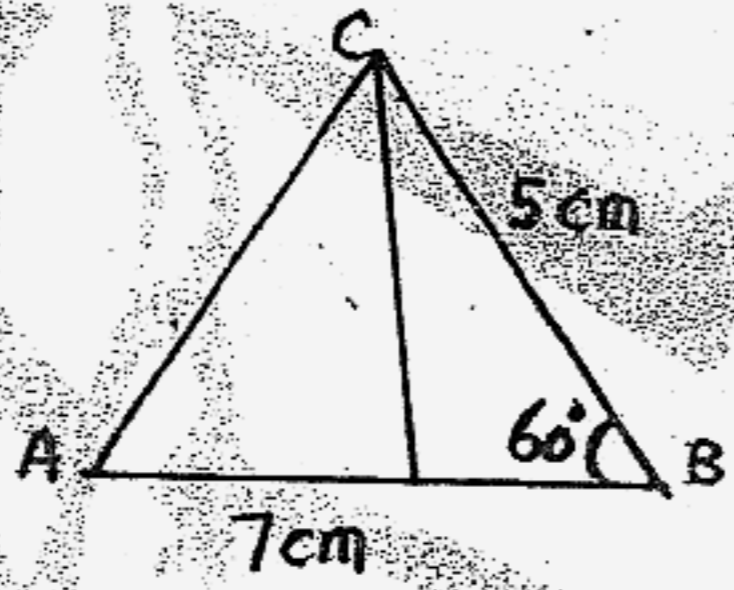

44b. 4.4cm

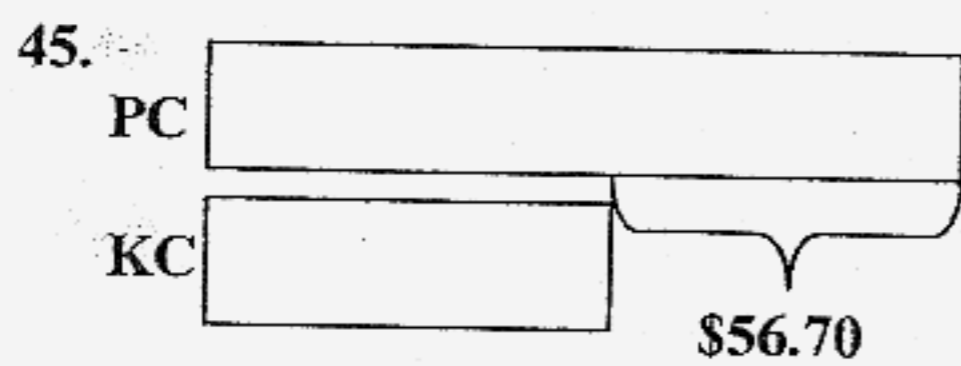

$$\begin{aligned} \text{Total cost of KC} &= \$(180.90 - 56.70) \div 2 \\ &= \$62.10 + \$56.70 \\ &= \$118.80 \end{aligned}$$

Every PC equals 4 KC

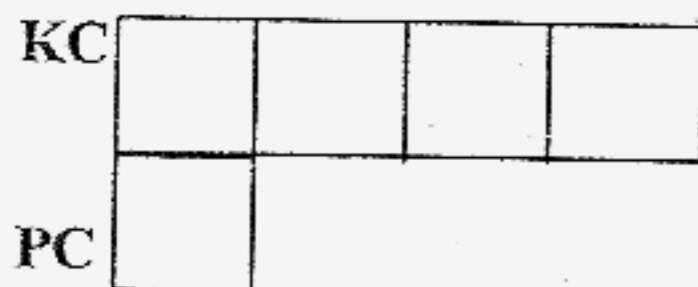

$$\begin{aligned} 4u \text{ of KC} &= \$118.80 \\ 1u \text{ of KC} &= \$ 29.70 \\ 1u \text{ of PC} &= \$ 62.10 \\ \text{Different} &= \$62.10 - \$29.70 \\ &= \$32.40 \end{aligned}$$

$$\text{No. of sets} = \$32.40 \div \$1.20 = 27$$

$$1 \text{ PC} = \$62.10 \div 27 = \$2.30$$

$$1 \text{ KC} = \$2.30 - \$1.20 = \$1.10$$

46a. Whole triangle = $\frac{1}{2} \times 8 \times 9 = 36\text{cm}^2$

$1u = 36 \div 9 = 4\text{cm}^2$

Unshaded = $4 \times 2 = 8\text{cm}^2$

46b. Length = $5 + 5 + 2 = 12$

Breadth = 2cm

Perimeter = $12 + 12 + 2 + 2 = 28\text{cm}$

Area = $12 \times 2 = 24\text{cm}^2$

47. $5\frac{1}{3}\text{hrs} = 320\text{mins}$

Filled up = $320\text{mins} \times 20\text{ml} = 6400\text{ml}$

Height of tank = $\frac{6400}{20} \times 16 = 20\text{cm}$

48. $15 : 25 : 2$